

## Evγ 30-23 4 t

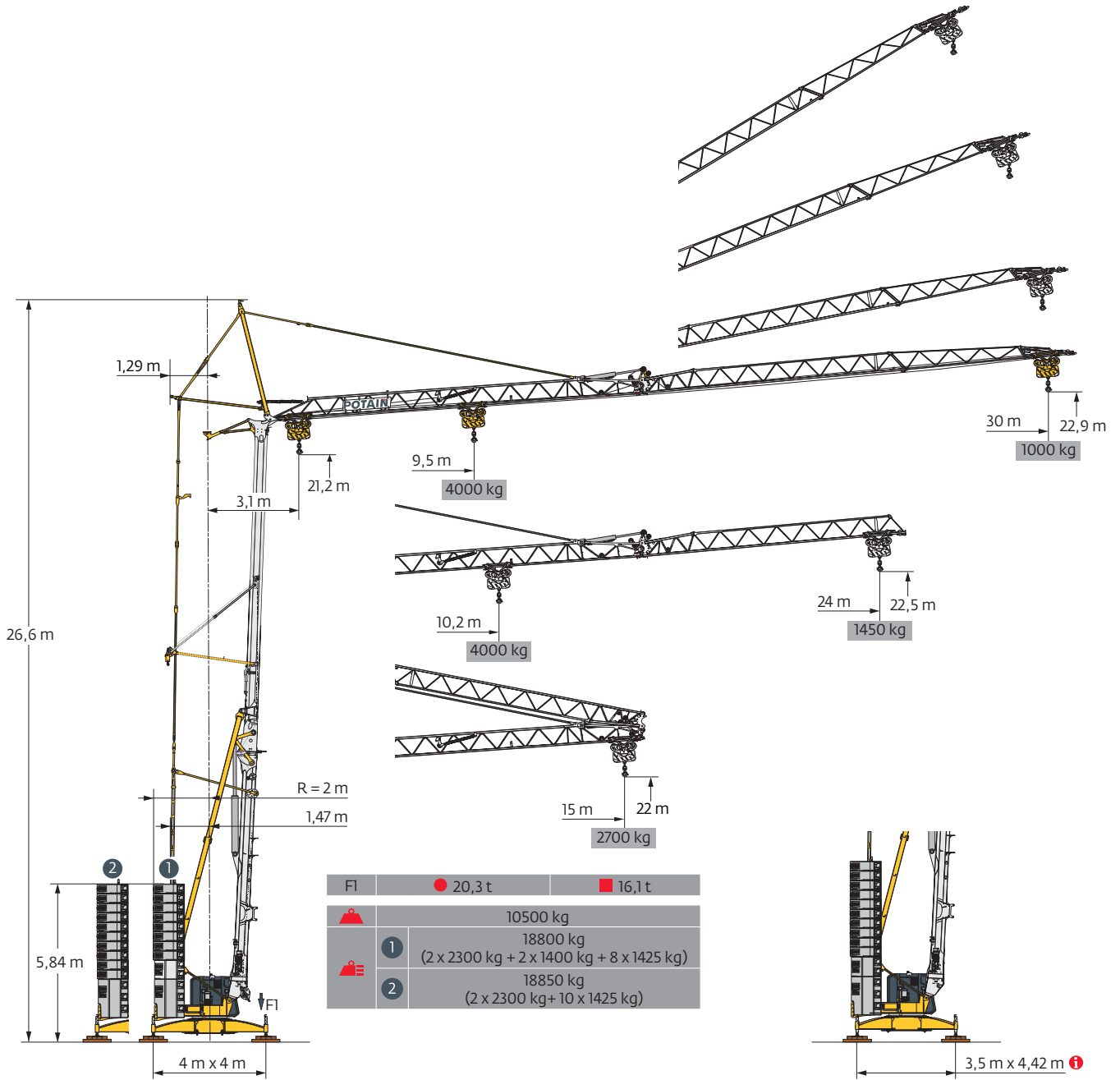

Smart Set-up    Drive Control    Power Control    POTAIN CONNECT    Top Site    Top Tracing 3

Courbes de charges / Lastkurven / Load curves / Curvas de carga / Curve di carico  
 Curvas de carga / Кривые нагрузок

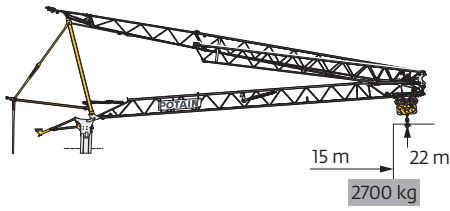

30 m	3,1	▶	10,8	11	12	13	14	15	m
▲▲▲	▼		4000	3900	3500	3200	2900	2700	kg



3,1	▶	9,5	10	11	12	13	14	15	16	17	18	19	21	23	25	26	28	30	m
		4000	3800	3300	3000	2750	2500	2300	2150	2000	1850	1750	1550	1400	1250	1200	1100	1000	kg

24 m	3,1	▶	10,8	11	12	13	14	15	m
▲▲▲	▼		4000	3900	3500	3200	2900	2700	kg

3,1	▶	10,2	11	12	13	14	15	16	17	18	19	21	23	24	m
		4000	3700	3300	3000	2750	2550	2350	2200	2050	1900	1700	1550	1450	kg

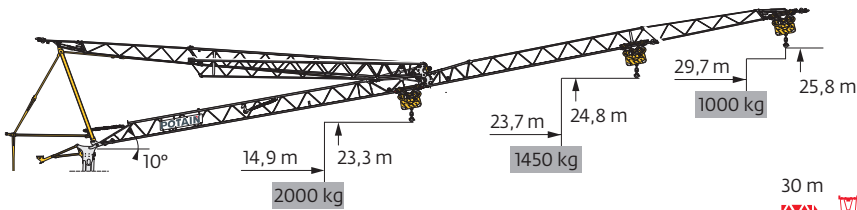

30 m	3,1	▶	16,7	18	19	21	23	25	26	28	29,7	m
▲▲▲	▼		2000	1850	1700	1500	1350	1250	1150	1050	1000	kg

24 m	3,1	▶	18,1	19	21	23	23,7	m
▲▲▲	▼		2000	1900	1700	1500	1450	kg

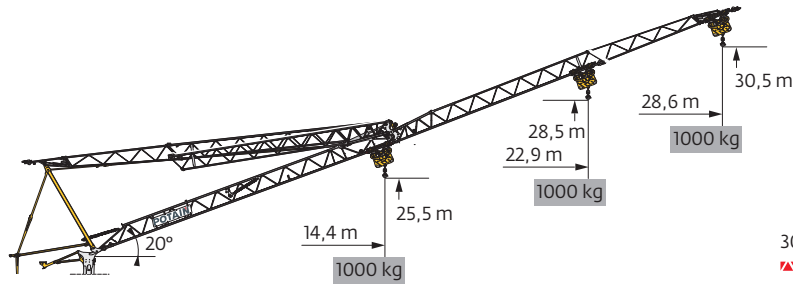

30 m	3,1	▶	28,6	m
▲▲▲	▼		1000	kg



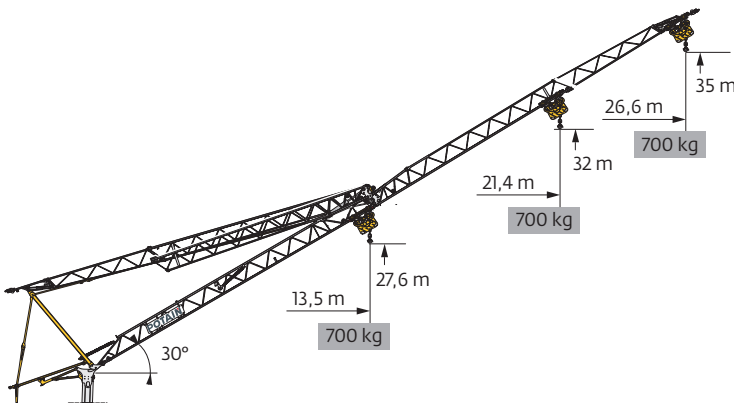

24 m	3,1	▶	22,9	m
▲▲▲	▼		1000	kg





30 m	3,1	▶	26,6	m
▲▲▲	▼		700	kg

24 m	3,1	▶	21,4	m
▲▲▲	▼		700	kg

Mécanismes / Triebwerke / Mechanisms / Mecanismos / Meccanismi  
 Mecanismos / Механизмы

400 V - 50 Hz 480 V - 60 Hz							ch - PS hp	kW	
	<b>18 HPL™ 10</b>	m/min	2,1	19	36	58	65	18	13
		kg	4000	4000	2000	1000	500		
	<b>3 DVF 5 Optima</b>	m/min	6,1	37	37	38,5	41	3	2,2
			4000	4000	2000	1500	1000		
	<b>HPS 131</b>	tr/min U/min rpm	0 → 0,9					4	3

 <b>IEC 60204-32</b>	 <b>kVA</b>	
400 V (+10% -10%) 50 Hz 480 V (+6% -10%) 60 Hz	18 → 11 kVA	

Montage / Montage / Erection / Montaje / Montaggio  
 Montagem / Монтаж

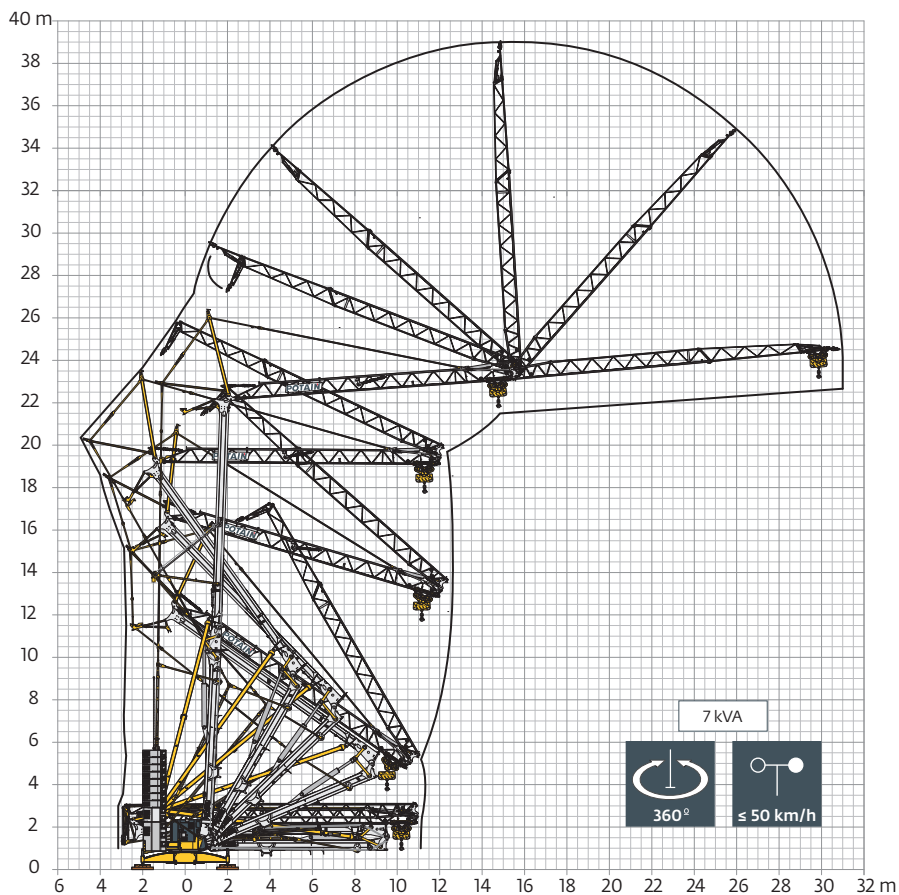

Transport / Transport / Transport / Transporte / Trasporto  
Transporte / Транспортировка

DS62/S120 - 10 km/h

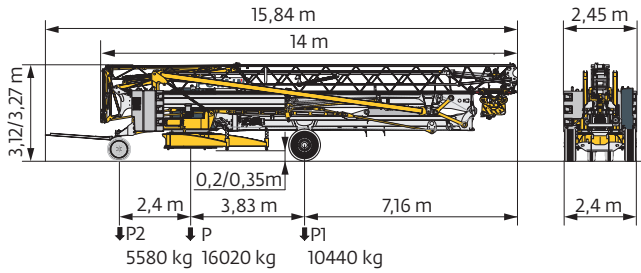

DJ105A/S125A, DJ126MA/S125A - 25 km/h

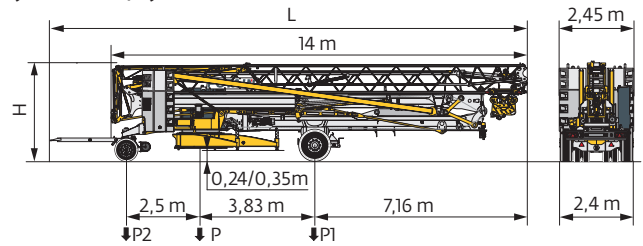

	km/h	L (m)	H (m)	P (kg)	P1 (kg)	P2 (kg)
DJ105A/S125A	25	16,06	3,14/3,25	16660 19460	10730 11200	5930 8260
DJ126MA/S125A	25	16,2	3,14/3,25	16820 19620	10740 11210	6080 8410

SL122/J215M - 80 km/h  
(EBS)

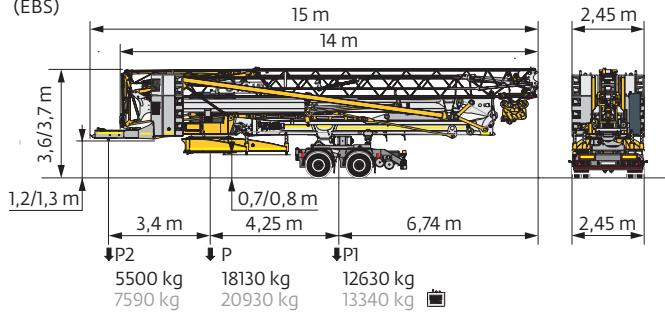

	FR	DE	EN	ES	IT	PT	RU
<b>R</b>	Rayon de giration	Schwenk radius	Rear slewing radius	Radio de giro	Raggio di rotazione	Raio de rotação	Задний габарит
<b>i</b>	Nous consulter	Auf Anfrage	Consult us	Consultarnos	Consultateci	Consultar-nos	Проконсультируйтесь у нас
<b>●</b>	Réactions en service	Reaktionskräfte in Betrieb	Reactions in service	Reacciones en servicio	Reazioni in servizio	Reacções em serviço	Реакция при работе
<b>■</b>	Réactions hors service	Reaktionskräfte außer Betrieb	Reactions out of service	Reacciones fuera de servicio	Reazioni fuori servizio	Reacções fora de serviço	Реакция в покое
<b>⚖</b>	Poids à vide, sans lest, sans trains de transport, avec flèche maxi. et hauteur standard.	Gewicht ohne Last, ohne Ballast, ohne Transportachsen mit max. Auslager und Standardhöhe	Weight without load, without ballast, without transport axes, with max. jib and standard height	Peso en vacío, sin lastre, sin trenes de transporte con flecha y altura estandar	Peso a vuoto, senza zavorra, senza assai di trasporto, con braccio max e altezza standard.	Peso em vazio, sem lastro, sem eixos de transporte com lança máxima e altura standard.	Вес без груза, без балласта, без осей для транспортировки, с максимальным вылетом стрелы и стандартной высотой
<b>⚖</b>	Poids total du lest	Ballast-Gesamtgewicht	Total ballast weight	Peso total del lastre	Peso totale della zavorra	Peso total do lastro	Общий вес балласта
<b>□</b>	Équipements standards	Standardausrüstungen	Standard equipment	Equipamiento de serie	Equipaggiamento standard	Equipamento de série	Стандартное оборудование
<b>□</b>	Équipements optionnels	Sonderausrüstungen	Options	Equipamiento opcional	Equipaggiamento in opzione	Equipamento opcional	Дополнительное оборудование (опция)
<b>⬆</b>	Levage	Heben	Hoisting	Elevarción	Sollevamento	Elevação	Подъем
<b>⬆</b>	Distribution	Katzfahren	Trolleying	Distribución	Distribuzione	Distribuição	Перемещение по стреле
<b>⬆</b>	Orientation	Schwenken	Slewing	Orientación	Rotazione	Rotação	Поворот
<b>kVA</b>	Puissance requise	Erforderliche Leistung	Required power	Potencia Necesaria	Potenza richiesta	Potência Necessária	Потребляемая мощность
<b>⚙</b>	Fonction Power Control : vitesses treuils adaptées à la puissance disponible	Funktion Power Control: Geschwindigkeiten der Triebwerke werden an die verfügbare Leistung angepasst	Power Control Function: winch speeds adapted to the available power	Función Power Control: marchas de los cabrestantes adaptadas a la potencia disponible	Funzione Power Control: velocità degli organi adattate alla potenza disponibile	Função Power Control: velocidades de guincho adaptadas à potência disponível	Функция контроля мощности Power Control: регулировка скорости лебедок в зависимости от доступной мощности

	FR	DE	EN	ES	IT	PT	RU
<b>⚠</b>	Hauteurs sous crochet données moufle plaquée	Hakenhöhen werden mit plattiertem Haken angegeben	Hook heights given with plated pulley block	Altura bajo gancho con pasteca bloqueada	Altezza sotto gancio con bozzello in contatto con carrello	Altura ao gancho com o cadernal em contacto com o carrinho	высота под крюком дана при условии, что крюковая подвеска соприкасается с кареткой
	Document commercial non contractuel	Unverbindliches Vertriebsdokument	This commercial document is not legally binding	Documento comercial no contractual	Documento commerciale non vincolante	Documento comercial não contratual	Этот коммерческий документ не является юридически обязательным
	Pour toute information technique se référer à la notice correspondante	Für technische Informationen, siehe die entsprechenden Anweisungen	For any technical information, please refer to the corresponding instructions	Para cualquier información técnica, ver la noticia correspondiente	Per tutte le informazioni tecniche fare riferimento al catalogo istruzioni	Para qualquer informação técnica complementar consultar as respectivas instruções	Для получения технической информации, см. соответствующие инструкции

